

Technical Arts 101
Prof. Anupam Saxena
Department of Mechanical Engineering.
Indian Institute of Technology, Kanpur.
Lecture No - 24

Now, to draw this you guys some of you guys, you have put in some hard work and whatever the score you would see over there is going to be at added up as extra credit in your total. So, you have taken the pain therefore, there will be some gain for you, so those, who did not those who did.

(Refer Slide Time 00:49)

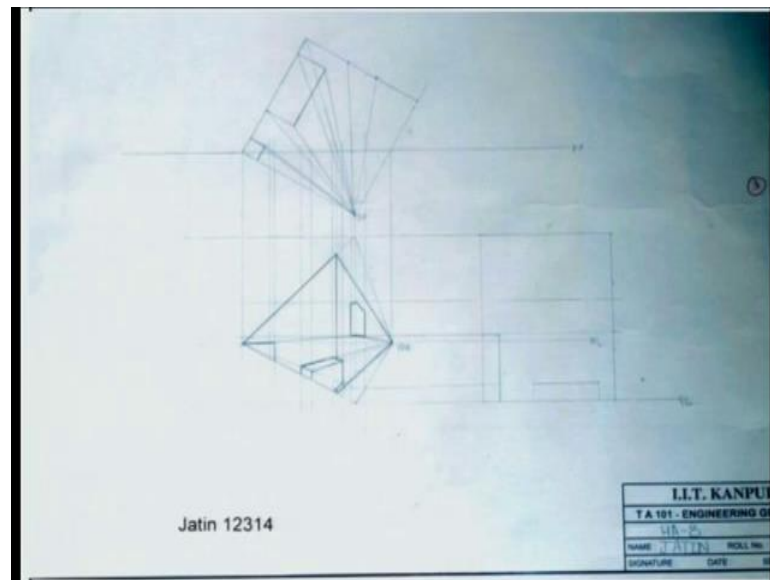

So, I will start from you know bottom up, so this is the first result, was not quite sure what, so he did not get much marks, but that is ok.

(Refer Slide Time 01:11)



Second, it is too large and vanishing points and station point and horizon line, they were not clear.

(Refer Slide Time 01:25)

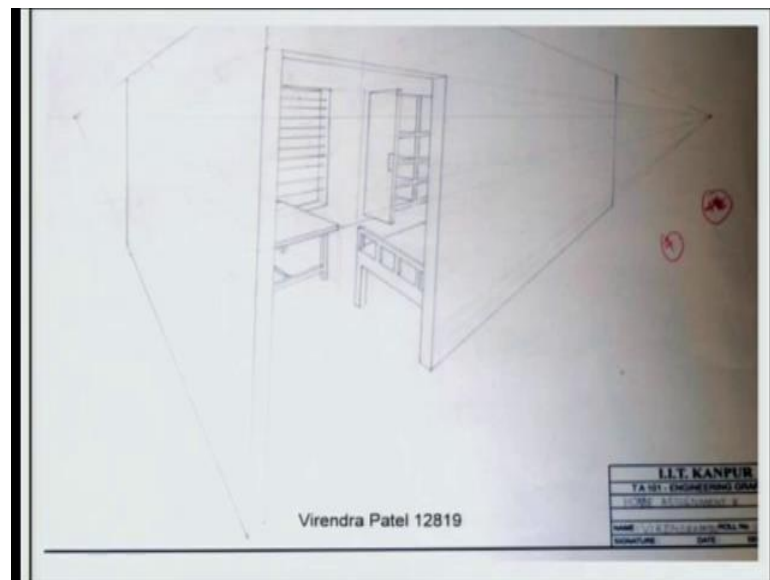

Third, Virendra is he there? Virendra, so maybe you took me too literally, so I said well I mean just stand by your door and see how your room looks like. So, you stood a little far from the door, but that is you know as an art as an art it is wonderful, it is great I mean. So, possibly Virendra is possibly, Virendra is standing over here. and he is honest he shows what he sees.

Deepak. he took me too literally, so he went far a Deepak Kumar, is he there? Deepak Kumar so not only was he standing a little away from his door maybe he went all the way up to the terrace of his hostel, and he is looking his room from there. so that is that is also a art quite detailed.

(Refer Slide Time 02:35)

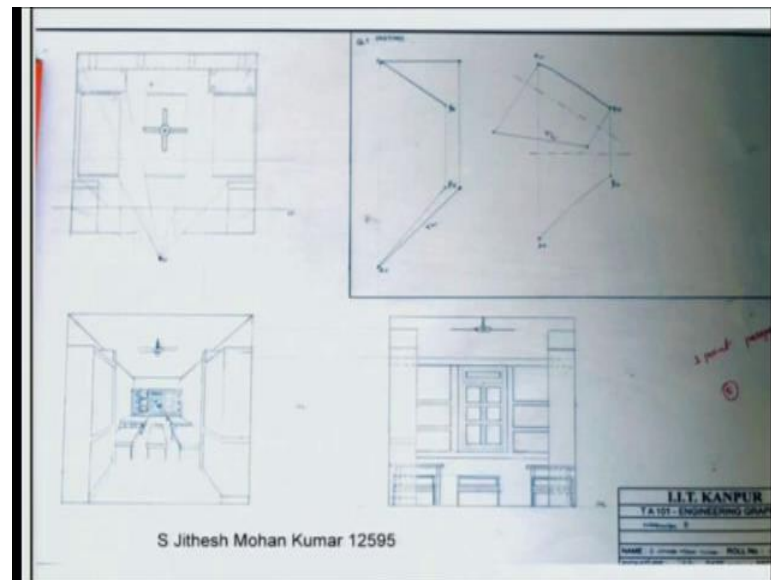

I wonder what this is, this one of the home assignments or class work assignments, Jithesh Mohan Kumar, are you there? What is this homework assignment or class work assignment or but, your drawing is quite detailed wonderful but, that that was a one point perspective what you showed was one point perspective good enough. So, in some proportion, the marks that you have gotten will get added up to your total, so you on only gain.

(Refer Slide Time 03:22)



Ravi Kumar, is he there? Again, a single point perspective, but wonderful.

(Refer Slide Time 03:32)

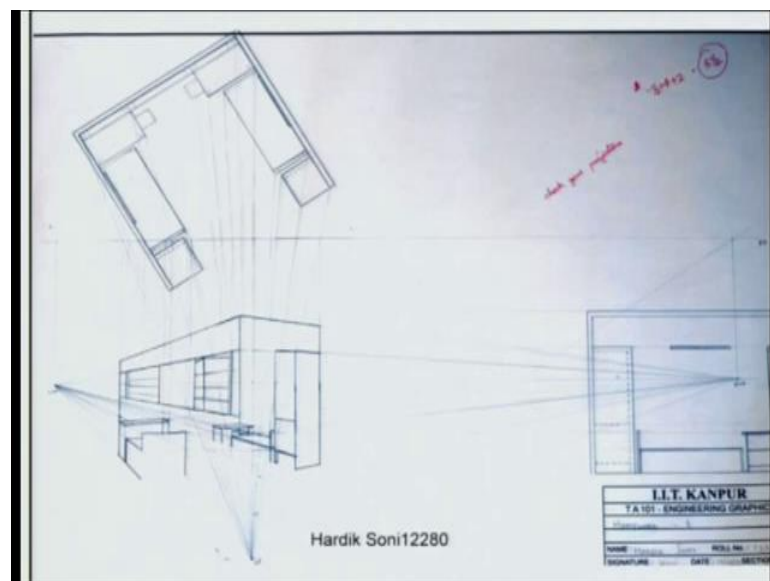

Hardik Soni, not there gone home, pretty nice I mean he started off with a side view or profile view or top view and he pretty much drew this perspective two point perspective, but he decided to somehow work with lines. You know a table would have a little, so it would not have any thickness, but line but that So which one? This one, but if you look at this table, so these are must be rods that is that is ok..

(Refer Slide Time 04:22)

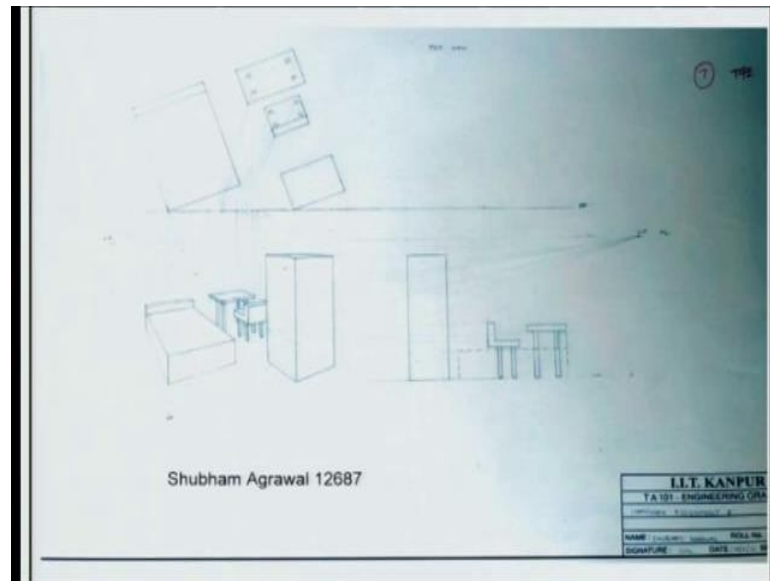

So, akashdeep alright, so you also did a pretty nice job I mean started with top view profile view detailed drawing of your room pretty nice. So, quiet of few step that we have Sameer Raja, pretty nice, but again I mean looks like you are working with lines, you could have shown some thickness that is Shubham Agrawal, nice effort.

(Refer Slide Time 05:02)

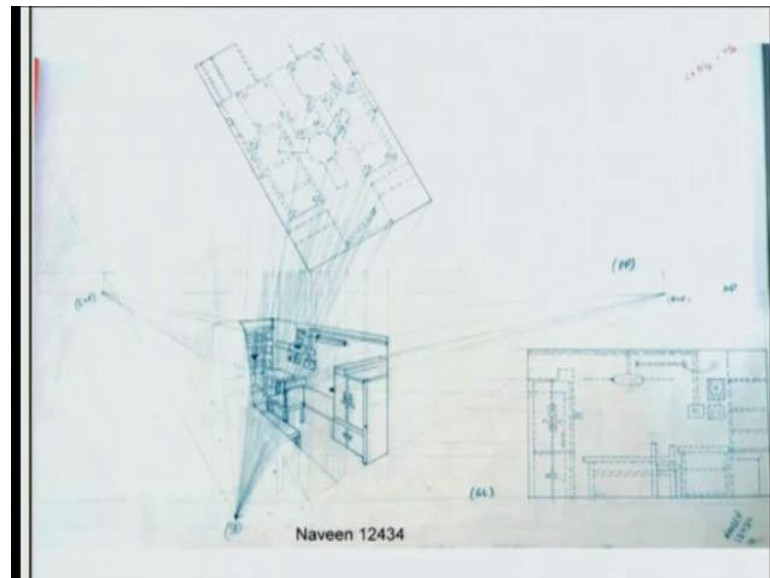

Naveen, naveen pretty nice effort detailed and you preferred to shade, so nice, so you know just look at the drawing and appreciate the amount of hard work some of you have out in this and I really appreciate that, so thank you very much. Aman Rusia,

Aman rusia, he starts with neat pretty nice detailed drawing, Ravi Raj, pretty nice height information, so that was something that I guess have you shown that theory could have been little better.

(Refer Slide Time 05:57)

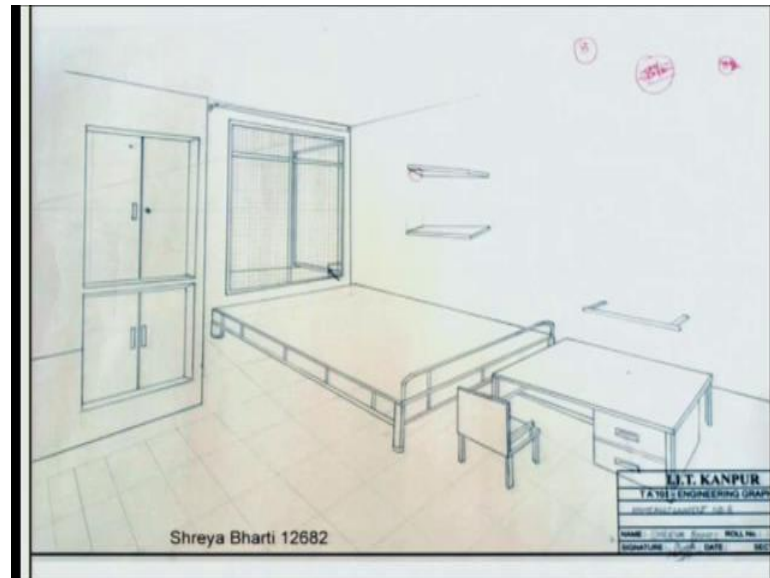

Pretty nice, very artistic,

student: what about the scale?

What about the scale? No, that was a one point perspective that is a reason why I would have gotten. So, this is a two point was it which one, yeah, but it hardly shows anything, well this came's too large within where are the vanishing points over and by the way, I did not do them. So, I asked one of my colleagues to help me out with that, so alright missing things yeah that information so and then of course the details top view and the profile view, how do you show in that? You know things would have been lot better, but still good enough I mean eight pretty artistic.

(Refer Slide Time 07:22)

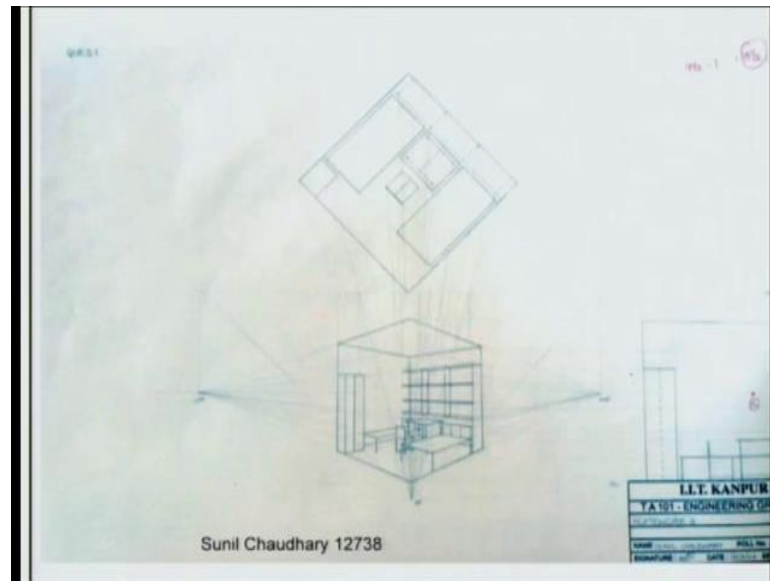

Sunil Chaudhary alright, so pretty nice again, so start with details and end up with pretty nice figure. Once again, i guess you have tend to choose lines there, so have you shown some thickness things would have been little better Kumar Jain, Ish Kumar Jain pretty nice, so he is the first nine.

(Refer Slide Time 07:48)

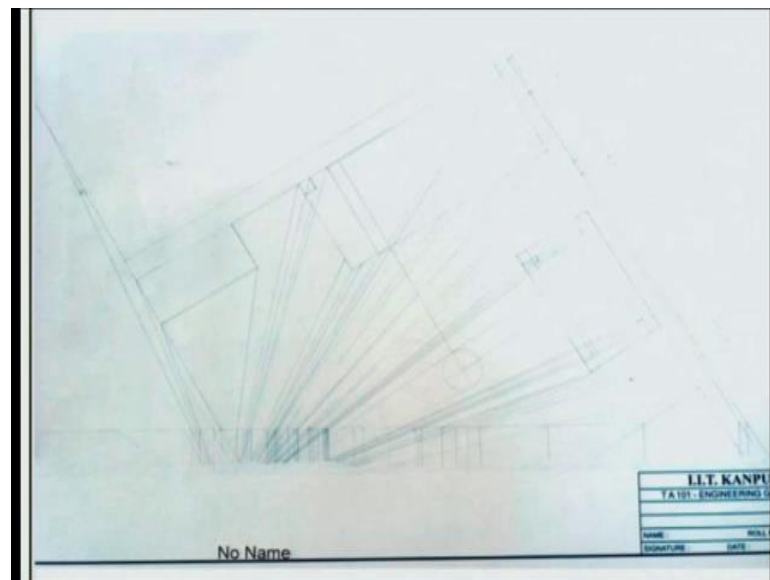

So, no there is a there is a little story behind this, this person used two sheets, so this was the background sheet that he used and his second sheet was this.

(Refer Slide Time 08:03)

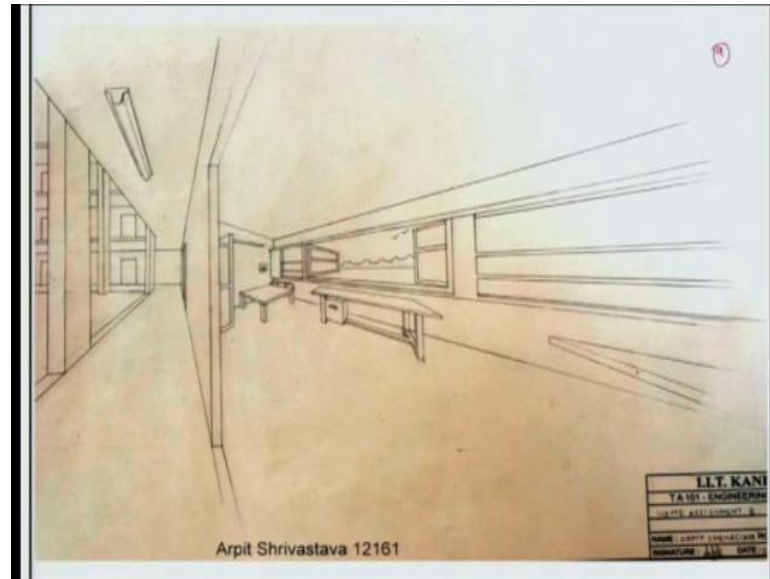

Pretty nice, so I am very glad to see some artists come in out or this class, so very nice I repeat, so looks pretty nice, but somebody else wins. So, the picture is not very clear, but if you look at the sheet, I am not sure if we have the sheet here, mohith call it luck or what I mean sonu has a pentagonal room. So, she starts with a pentagonal top view, pretty much all the detailed information in the profile view here. One thing that positively went to her favor was that she was able to show that you know there is another vanishing point, the third vanishing point. So, technically it is pretty good and its pretty neat, you know for quite some time I was pondering what should I give and the best thing that i could give is which I am giving.

I am giving some more marks alright star, well that mean wait till your ends sem exams all over, I will be and trust me I will be eager I will be eager to give as many as possible, but I need your support for that. So, if you do well in your sem exams, I will be very happy to give you A's and many A stars, but if you do not do well in your exam I would not have that support that I am looking for. So, if you promise me that support, I promise you the grade you give me support, I give you grade.

So, auxiliary views, so quiet of you would have gone home I believe that is we discuss the simple example last time so many of you were not here, but for your benefit probably go through this again.

(Refer Slide Time 11:17)

Topic	Week (No. of Lectures)	Lab
Intro and Basic Constructions	Week 1 (2)	
Orthographic Projections	Week 2 (2)	Lab 1
Orthographic Projections	Week 3 (2)	Lab 2
Isometric Projections	Week 4 (2)	Lab 3
Missing Views	Week 5 (2)	Lab 4
Sectional and Assembly	Week 6 (2)	Lab 5
Oblique Projections	Week 7 (1)	Lab 6
Perspective Projections	Week 8 (3)	Lab 7
Lines and Planes	Week 9 (2)	Lab 8
Lines and Planes	Week 10 (2)	Lab 9
Auxiliary Projections	Week 11 (2)	Lab 11
Intersection of lines/planes/solids	Week 12 (2)	Lab 11
Intersection and Development	Week 13 (2)	Lab 12
TOTAL	26	12

So, look at where we are now in the week we are in the eleventh week, we have opt to this four more lectures to go to on in different an on to development. So, you will have to bare me for four more hours and the end sem exam.

(Refer Slide Time 11:40)

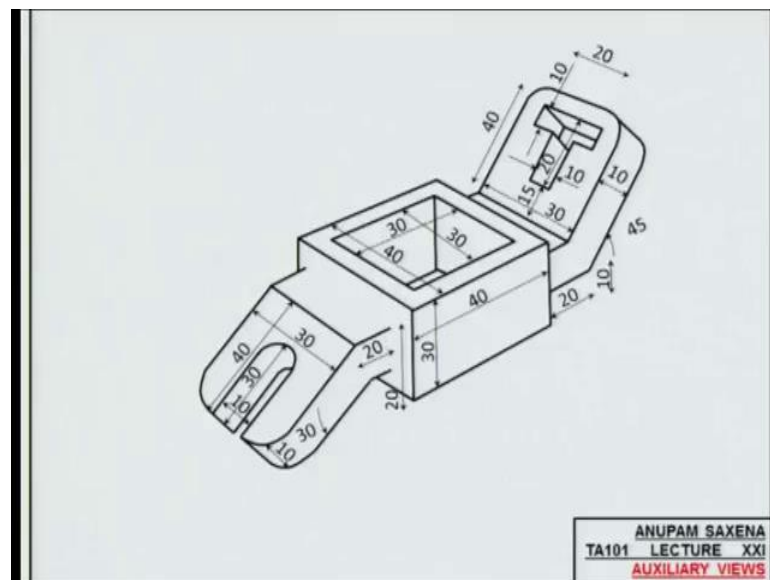

So, this is the example problem that you will be solving in number 11 I believe lab number 11. So, you already have the solution if you do not I will go through so we need to figure out the view of this object and the top view of this object. The trick is that two of the planes that you see they are inclined, they do not get aligned with

either the horizontal or vertical. So, it becomes little difficult for you to draw the conventional orthographic view of this drawing, so what you do? You take the help of auxiliary plane get the true shape of the object on these planes and transfer that shape correspondingly in your front view and the top view.

(Refer Slide Time 12:38)

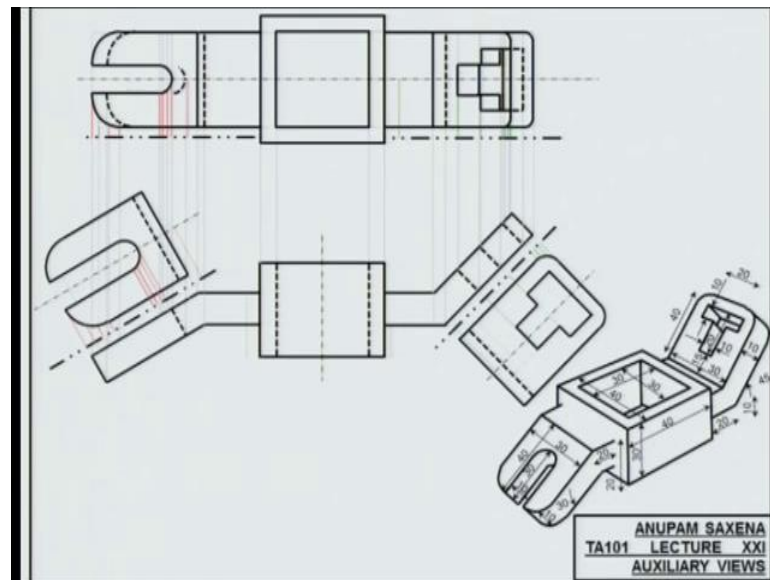

So, the center part of the object not very difficult to draw, so maybe I will just run through that. So, it is a block, some dimensions, some protrusions coming out from the right from the left and of course, this angle is giving I think its 45 degrees. So, this angle is given, so perhaps I can get the thickness of the planes on both ends, so this is the base this is the primer and then I project some features in the top view that I can. So, in from the top it is going to be hollow box inner way with some thickness, so hidden lines center line and if you want to and you have to that so to be able to capture the true features on this plane. On this plane, you have to draw you know those features in the corresponding auxiliary views.

So, if you flip this plane by 90 degrees, you will get the true features here and likewise if you flip this plane by ninety degrees you will get the true features over here. So, here it is pretty much like a slot and well it is, so it is a semi circular slot and here you have a t slot. So, let us try to get that yeah here why the center line is should be there should not be there, why it should not be there? It should not be there do you have any eraser, we will just erase it, so ignore that. So, coming back to the

true features on that planes, so this length is going to be 30 from here to here, it is thirty, this would be about you know 40, so this total length is 40, so you have to draw a few arcs on both ends here and here.

So, get the slot not very difficult, get the arc get the arc and you have the true features on this plane on the auxiliary plane, the second one is it for me to have the center line here. Of course once we this thing here and the auxiliary view I will have to come back and update my top view update my front view. So, I will have a dash line corresponding to this feature and on the right hand side again something very similar drawing that is not going to be very difficult. So, it is a t slot that we have and once I have this auxiliary view, then I come back to my top view and I update that. So, I have corresponding hidden lines, so is it for me to have a central line here also, yes or no? Why not? Why symmetry?

So, this central line is representing symmetry alright, so is my front view done am I done with the front view? Am I done with the front view or do I need to do something else? Yes or no? Answer, am I done with the front view? Good, not yet, how about this line? With this line correspond to no which one which one this one or this one this one, should it be hidden? Should it be solid? Am I right? It should be hidden line, so yeah, so because you have flipped thing like and likewise you will have a line corresponding to this. Once your auxiliary views are finalized and through with start working with the top view and this is where I would need your attention.

So, pay attention, this is where things get complicated because transferring these features from here to the top view is little tricky. So, first get the projections match the projections, so corresponding to this corner here, you will be seeing a solid line corresponding to this one, you will be seeing a dashed line, central line should I have a central line here? The object is symmetric with respect to that, pay attention we will transfer these features on to this feature, now you must have studied something way back, maybe five six lectures ago how to do that, something very similar. So, this is one of the views a hinge line, second view, third view right, so do you recall how do we transfer distances?

Exactly the same thing, so I am going to be projecting these features up and this is the tricky part, I have not yet identified the hinge line that would separate these two features and how would I want to do that. I already have the hinge line here because if I do not do this, I will mess up the transfer of features from this auxiliary view to here stay.

So, you have to be able to locate this hinge line properly because if you do not then you will miss up your transfer of points from this auxiliary view up to this top view. Now, to this hinge from this central line, I locate this point over here and I draw a little hinge line, now this hinge line is local in the sense that this hinge line represents only the relation between these two views. Now, once I have located the hinge line over there becomes simple, I will measure this distance, I already have the projector up over there I will transfer this distance over there, likewise I measure this distance, I transfer this distance over there and what am I doing?

Now, measuring this distance my projector is here, so I am projecting the top face now, so I am projecting this face now, not this face measure distances transfer distances and then project this guy up over there. Measure this distance transfer that distance; once I have all those distances over there, it is easier for me to make this t yeah, why A v, you can. So, what you are saying is these distances they are remain the same, is this what you are saying that these distance is same is distance that gets a foreshortened. You could do that if you want to do, if you want to draw this directly you could that, so I am just explaining the procedure, the procedure for a little more complex looking objects it may not be visible for you to draw it the way you want to.

So, having worked on the object, now working on the bottom face of the object, exactly the same things are visible and invisible. So, this part inside the previous t is going to be visible, this part is not going to be visible, so it is going to be shown using hidden lines. So, this part of right there, where am I know how about this arc that you cannot draw directly. So, you will have to take projections and you will have to measure distances precisely. So, look at this arc transferred this arc over then from the top view from the front view to the top view that arc into number of small segments do see this, do you see this lines, or you do not you do not?

So, there are few lines over here, so this arc measure distances from the hinge up to different points from the arc projectors from here measure these distances light green lines over there, here, here, here. So, once you get those distances then becomes little easier for you draw the arc, likewise on the top draw the horizontal lines is this going to be visible or this going to be hidden visible, how about this? Is this going to be visible or this going to be hidden and would the arc corresponding to this plane here be shifted to the left right shifted to the right.

So, once you have gotten this arc over here if you are smart you can just directly shift that arc to the right by the requisite amount or you can take the projections from here and get that arc at its proper location. So, the top view becomes a little difficult to likewise on the left same thing exactly the same thing. So, you have this edge drawn, the edge corresponding this corner will be visible how about this corner visible invisible hidden and then start taking projections start measuring distances transfer distances and get your top view in order.

This is for the arc, likewise on the top that part is going to be visible, how about this arc? Exactly, the same procedure discrete this arc into a bunch of points measure distances from this arc, from the hinge line and transfer those distances on to your top view. Likewise, on the top join these guys this is for the top face, this for the top faces how about the bottom face, why this is local and why this local true, is true, true. Then, I will have to be a little careful because then I will have to figure out that and this hinge line. So, what I am saying is if I locate this hinge line independently, if the location of this line is again independent from this, then the choice of this would depend on how I have to locate this hinge line.

The choice of this hinge lines how I have located this hinge line. You can directly measure distances. So, if you do not want to measure the distances from this hinge line and rather yeah I have come to that, so let me see if I have gotten you right. So, if you do not want to measure distances from this hinge line, rather if you want to measure distances of these points from this edge. You can use this edge as reference and transfer distances accordingly is this what you are pointing at is this what you are aiming at.

You can which is what I am saying you can but, you'll have to be a little careful. So, if you want to show a common hinge line that separates this view from this view you can, but when you do that the location of this hinge line and this hinge line. They will be relative this is what I am referring to. So, wow after the mid sem break you are going to be rocking this example, so try it out.

So, if you choose to represent both these hinge lines by a single hinge line, they make sure that these distances they are properly correlated at this sign; they are independent you see or it mean or maybe will discuss this yeah. So, how about the features on the bottom face this is here identical procedure. So, of course like here like you see this arc over here you would also see this something very similar at the bottom face, but if you look at the top view this arc will get shifted inward. Since, this is at the bottom this would be shown using hidden lines likewise the inner slot over here.

This will get shifted inward corresponding to the bottom face and it would be shown using hidden lines did I miss out on anything else? Is everything there? Sure alright, so why because I am leaving you 10 minutes earlier.

student: Yes sir.

You are too bored with TA 101 is it?

student: Yes sir.

Too bored with TA 101?

student: Yes sir.

Why are you bored? Well, if I have made you work a lot if I have made you work a lot I am not sorry about that no, but it is not their fault it is my fault I am making you work harder. Come on, you are learning so many things, isn't it? I will give an example, so think about this what come on you are fresh from your j a exam you know s l no leys l lonely by hart you know you know all your physics books Restic Hadley is it or Restic Hadley or is there any new book that I am not aware of, H C Verma.

(Refer Slide Time 34:23)

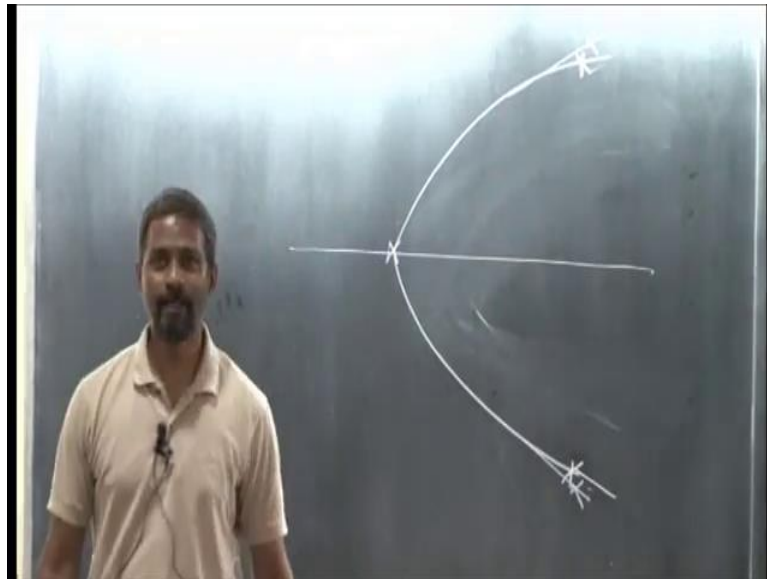

So, given three points on a hyperbola given three points on a hyperbola, let us say this is your access and your hyperbola is symmetric about this how do you construct it hyperbola. My drawing, I mean it should have been, it should have been more like that given three points on a hyperbola, how do you construct it? I am not interested in the algebraic solution, I am interested in the geometric solution how do you construct that, see, think and analyze if you have done your t a 1 not 1, well maybe I can expect a solution from you guys in aother 5 or 10 minutes if you have not.

They are symmetrical, but I need only one of these points not two how do you construct these geometrically given three points on hyperbola is what it means, what is it mean is then it should have been ISH, that is and word is yeah.

Come on, come on, you have hyperbola problem to solve, so I have smart people in front of me people from come to science electrical, mechanical, mathematics, b s b all of you guys have done s l pretty nicely. I mean pretty properly three points on a hyperbola, how do you construct it geometrically? French curves come in come here, come here, come here yeah, four more guys to, so left him 4 more guys to, so left him French curves.

Why not use the compass and draw an arc man, they will be more accurate, yeah alright I am not saying that anybody with the solution? Yeah, step out step out.

student: sir, we construct a triangle.

Triangle.

(Refer Slide Time 38:54)

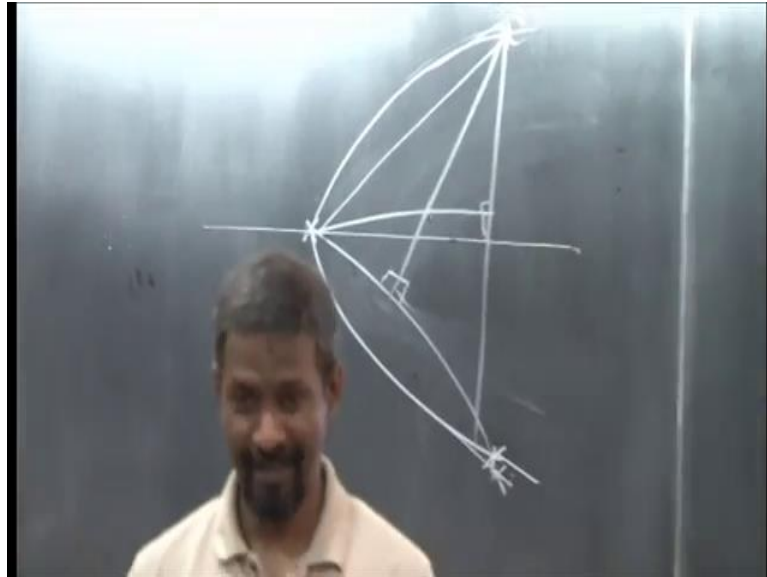

You have a piece of choke take a piece of choke and explain it.

student: this point will lie on hyperbola.

This point will lie on the hyperbola, well these three points are lying on hyperbola its if three points are hyperbola. So, these three points are already there on the hyperbola, how would, how would this point lie on a hyperbola, yeah fine so construct it, construct it, yeah anybody else anybody else. Most probably, so can you verify that and I will take some time, what there is, there is a very obvious solution. Now, I guess I should be saying $t a 1$ not 1 is so difficult I have absolutely no idea about these methods. So, when you return and please do return after a mid sem break, we will talk about these interesting aspects of $t a 1$ not 1 intersection and development. So, it is pretty fun and lot of lot of, but pretty fun also, so happy hol, go home.