

Technical Arts 101
Prof. Anupam Saxena
Department of Mechanical Engineering
Indian Institute of Technology, Kanpur

Lecture - 15

Let us get started Baradwaj can you hear me, M for...

Student: ((Refer Time: 00:28))

Have you heard that term before, A for apple, B for [FL] apple, C for...

Student: ((Refer Time: 00:48))

D for [FL] apple

E for...

Student: ((Refer Time: 00:54))

[FL] apple

So, M for Mid Sem, M for marks, what is M for again?

Student: ((Refer Time: 01:04))

What?

Student: ((Refer Time: 01:10))

[FL]

Yeah, what is M for again?

Student: ((Refer Time: 01:19))

Empty, [FL].

Student: ((Refer Time: 01:27))

One more word.

Student: ((Refer Time: 01:54))

Relate these four words now...

Student: ((Refer Time: 02:13))

Let go of the Maya for marks and rather look at...

Student: ((Refer Time: 02:29))

So, remember these two words think and analyze, most of you are 18 plus, so you are adults you have the right to vote, let go of the idea that you should be running for marks, learning is what is more important later on. Important thing is you have to be thinking and analyzing, so mid semester results, this is where clapping starts we have had century makers, those who have scored 100 and more.

So, what I will do is I will project the names and role numbers and they need to stand up and raise their, so to speak that, so for them the back would be mechanical pencil or a normal pencil or they do not have a just a pen and then, you guys can clap. The first one, there raise it hand, second, ((Refer Time: 00:58)) where is a pen, more ((Refer Time: 05:23)) Natya, Avikalp.

Student: Gone.

Gone [FL]

((Refer Time: 05:46))

Tired or what?

((Refer Time: 06:11))

How many more...

Student: Three, three, four

One more...

Student: Yes sir...

Guess his or her marks

Student: 120

113

Student: Yes sir

Guess his role number or her role number

Student: ((Refer Time: 07:54))

And his name is of course

Student: Arpit

You know I feel very happy, I feel very happy and privileged to be teaching this batch, that it is one of the smartest batches that I have seen in long time, so clap yourself ((Refer Time: 08:34)) having said that, these are the numbers that you guys are interested in. Scary, why can say about this row is something very simple just 25 percent in your hand, rest is again in your control 25 percent for your labs, I think 5 percent for your homework's.

Student: ((Refer Time: 09:16))

10 percent for your homework's, 25 percent there and then of course, 40 percent for your intense, so plenty of still, plenty of runs on the pitch, so you guys can score, so do not worry about this maximum of courses full marks in all questions ((Refer Time: 09:37)), wait, I make a lots of mistakes do not worry about it, so that 113 should I think the 120. That should be 120, these are the averages, so about 100 and 99 of you plus 1, 200 are above average 200 and 20 are below average, which is again not a reason to worry, you still have about a lot of things in your control, you can always score plenty of runs, plenty of marks and again keep Maya and Moksha in mind.

So, let us continue with perspective views, Shrikanth Singh is he still there ((Refer Time: 10:54)), Prajapathi ((Refer Time: 11:08)) by the way a few comments, so regard to the Mid sem exams I had requested you guys to not bring your cell phones and bags. It was wonderful to know that only 11 of the 420 that I have, they brought the cell phones, the

rest of you did listened to me which is the wonderful thing, thank you. Of course, I give the cell phones back to them, I thought they were present to me, but they would not back, so I give it to him, this belongs to someone in here.

Student: ((Refer Time: 11:57))

We talk later

Student: Sir another thing

We talk later, so perspective views.

(Refer Slide Time 12:21)

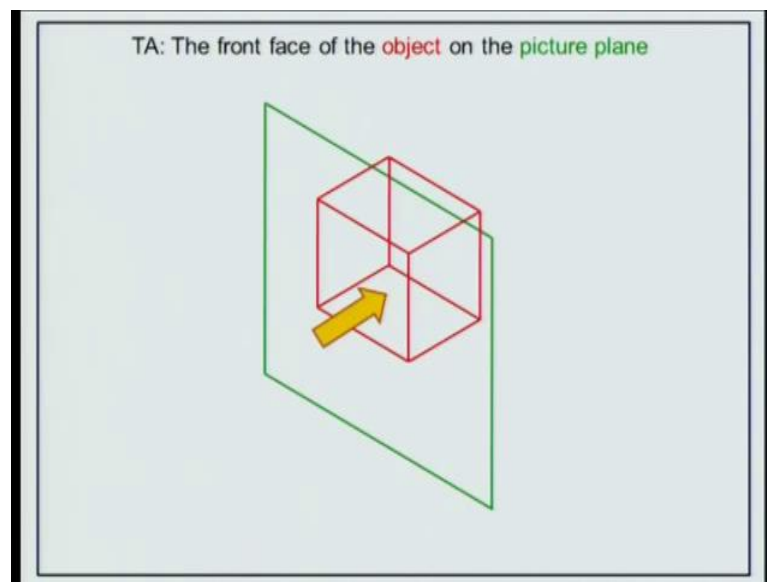

So, last time I guess I was a little bit technical, I probably dint explain very well how to draw perspective views can you close door please, can you close that door, thank you. So, I thought maybe I will explain perspective views in a slightly different perspective, so I have this hollow box in front of me looks like this. So, each of you will have a slightly different view about this, because your station points, your respective station points are different.

But, what is something that I want to you guys observe are the inner vertices, can you see those inner vertices, can you see these guys from there, not quite, not quite may be if I bring this closer to you, inner vertices try harder, these guys from this window, you can see this. And one another observation that you would make is that these guys if they

these lines these vertical lines, if they run to infinity they would converge to a point, that is observation that you can make easily.

So, that is it, let the green plane be the picture plane and let this plane be on the front face of the object. So, this is where this loop is, this hollow box is and the picture plane is right here touching this face of the object and of course, this is view direction you are viewing at this hollow box straight through.

(Refer Slide Time 14:36)

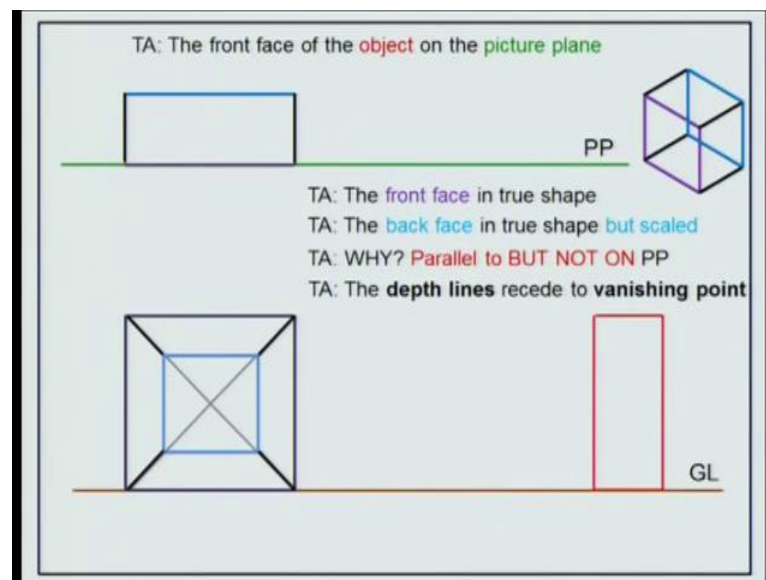

So, your perspective is usually going to looking like this, so what we will do is work this example backwards, given the perspective get all the essentials that are required to make this perspective, so it is slightly backward example, are We little slow, so you guys to stay with me. This is how the top view of this object is going to look like very straight forward, these how the top views are going to look like. And of course, as I said the picture plane is on the front face of the object, so the green thing is going to be the picture plane PP.

Now, profile view and this is ground line GL, which is this face of the object, which is this face of the object, it is this face and since this face is exactly precisely on the picture plane it is going to be in true shape. Two dimensions of all the 4 edges and true shape, because this face is right there, above this face this face is the back face, what you have to say about this face is it going to be in true shape, careful is it going to be in true shape?

Student: Yes sir

Good, is it going to be in true size

Student: No

Good, the back face is going to be in true shape, but is going to be scaled, why because all the edges of the back face are parallel to the picture plane, but not on the picture plane, that is the reason why is going to be in true shape, yet they are not going to be in true size. This is the back face of the object, about these edges here the 4 ones, what you have to say about this are they converging to a point?

Student: ((Refer Time: 17:34))

And they correspond to those depth edges of the object, those black ones here, what you observe about these edges, are they on the picture plane, are they running away from the picture plane, if they are running away from the picture plane in perspective, they are going to be seen or they are going to be showing up as a set of lines which are converging to a point. These black lines corresponds to these depth edges of the object and one observation that you guys make as the depth lines they have to recede to a vanishing point.

So, four observations, let me repeat the front face of course, is in true shapes, so anything of the object which is on the picture plane is going to be in true shape and is going to be in true size, anything which is on on the picture plane. By the way this picture, what was this picture correspond to any idea, this scheme is something very similar to autographic views, you have a front view, you have a top view, you have a profile view.

But, what was this guy correspond to, this guy is going to be corresponding to the image of the object on the picture plane in the front view of course, so that is the picture plane this is the object stationed relative to the picture plane. So, you will see some image of the object and if you kind of rotate this thing, this is what you are going to be seeing, so keep that in mind. So, of course, these guys are converging and they are converging to a single point, it is called vanishing point.

(Refer Slide Time 20:04)

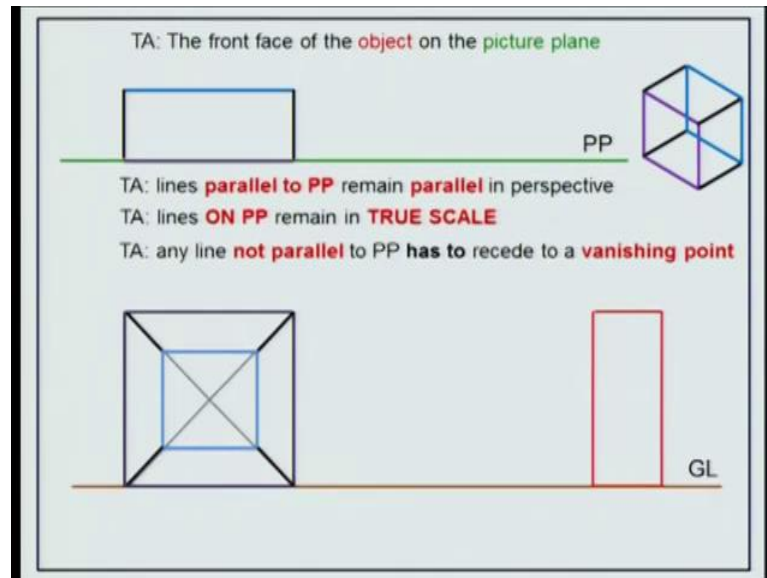

And then, based on these observations we kind of frame a set of rules, so thanks to my conversation with professor Kishore, so he had draught by my office I guess 2, 3 days ago, professor Kishore was it 2, 3 days ago and then, we had this little discussion from where I kind of summarized these rules for you. Lines parallel to the picture plane always remain parallel in perspective, lines parallel to the picture plane.

So, these are the lines which are parallel to the picture plane what else, lines which are into the screen they are also parallel to the picture plane, so they will always remain parallel in perspective rule number 1. Lines on the picture plane will always remain in true scale, role number 2, role number 3 any line not parallel to the picture plane has to recede to a vanishing point, so these are 3 rules, that you in to be keep in mind.

(Refer Slide Time 21:29)

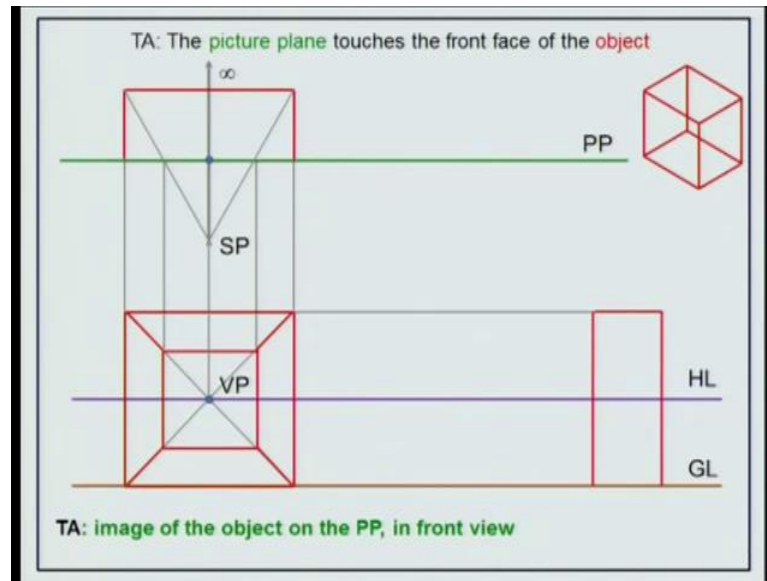

As I said this guy here is the image of the object on the picture plane in front view, that is my vanishing point, vanishing point has to lie where horizon line, this my horizon line HL. So, remember I am working this example backwards, starting with the perspective I am trying to figure different features that are required for me to draw that perspective. I have the horizon line and then what this face, this face is going to be in true shape and you can get the true shape directly by projection, from top view as well as a profile view.

Look at this face is going to be scaled of course, how do you get that scaling you need one more parameter, what is that parameter the station point, how do you get the station point like so. If you look carefully this face is the image of this edge in top view carefully, if you look at the top view this is what you are going to be seeing for that face, image of the back face of the object on the picture plane, project these guys upward to a top view.

So, this point is the image of this point here, this point is image of this point extend the two lines, the intersection of these two lines will be what this station, do you have everything now. Do you have everything to regard to this perspective view, yes or no, no serious faces serious eyes, all the energy gone, what you have to say about this guy, this line here what you have to say about this line?

If you stand at the station point and look along this direction, which is parallel to the depth direction at infinity, focus on object at infinity the image of that object will be

what, a point. This point is going to be there, project that point back to where the horizon line, that is where your vanishing point is deep stuff yes know, one more time we will quick...

(Refer Slide Time 25:39)

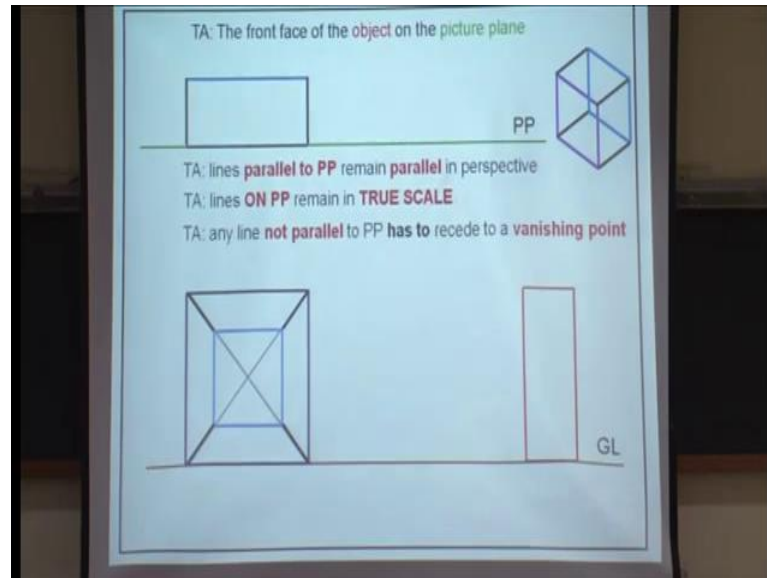

Keep these 3 rules in mind, lines which are parallel to the projection plane or the picture plane, they remain parallel in perspective, lines on picture plane they will remain in true scale, any line which is not parallel to the picture plane has to vanish to a point. Now, look at the top view, how many lines do you think are not parallel to picture plane, 4 they will all have to vanish, they will all have to vanish to a single point or to 2 points, single point why not 2, why not 3, why not 4, we will come to that question later.

The image of the object is on the picture plane in front view, that is a vanishing point, horizon line look at this face, this face is going to be in true shape, we can get this face directly by projecting features from the top view and the profile view. Look at the back face, the back face is going to be the image of this edge, in top view how do you get this edge, you have to have a station point for that, to get the station point project these guys back remember, we are solving this example backwards project this guy back.

So, this point here is the image of this vertex, ((Refer Time: 27:35)) this point here is the image of this vertex, this point is image of this vertex join these two guys, in section these two guys would be the station points. And if you look along the depth direction, there is only one depth direction here, if you look along the depth direction towards the

infinity, look at the object the image of that object on the picture plane will be a point. And if you project that point back to the horizon line will be getting the vanishing point, all these guys are related to each other.

(Refer Slide Time 28:20)

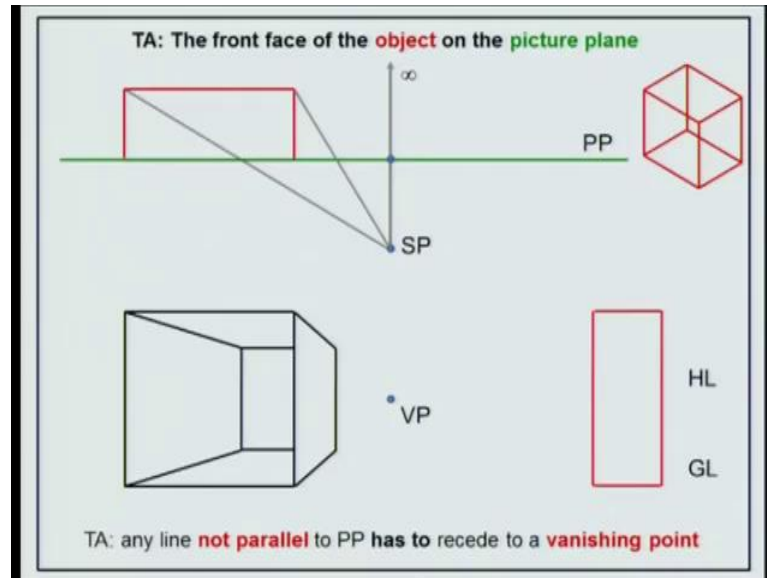

Now, what if I move the station point, instead of having the station point here in the middle, what if I move the station point to the right, back to the loop this is where loop is, what you saw was a bunch of you guys look at the perspective of this. Now, the new perspective corresponds a bunch of you guys looking at this, station point, picture plane, the loop, top view like that, let us look at that.

We have a station point, first let us get the vanishing point look in the depth direction, which is a single depth direction, look at an object at infinity the image of that object will be a point on the picture plane, project that point downwards to be horizon line, this is your vanishing point. Once you have this vanishing point of course, the front face of the object is on the picture plane, get the true shape from the profile as well as top view and then, from here to here the edge is going to be vanishing where...

From here to here the edge is going to be vanishing like so and how about the bottom edges, the bottom of this is going to be vanishing like so and this one is going to be vanishing like so so we have to figure out these edges in the front view. And remember this rule any line which is not parallel to the picture plane has to recede to a vanishing

point, one this edge is what the top edge, this guy here above this edge, this guy above this one and finally, this one.

Let us get the back face for that we need the top view, look at the back face from the station point, so the back face is essentially an edge in top view, what is the corresponding image of the back face is going to be this line, project this guy downwards. And the intersection of this line and this line will give you one vertex, this line and this line will give you the second one, this line and this one the third one and I need to project this thing back over here, so this will remain fourth one.

So, the first edge, the second one and would this be a partial edge or a total edge?

Student: ((Refer Time: 32:23))

Would this be a partial edge or a total edge

Student: ((Refer Time: 32:27))

And then I get the depth edges done, now just imagine if you just let go of this projection lines, how the perspectives going to look, with me any question so far, Baradwaj hear me any question so far [FL]...

Student: Can you explain vertex HL, GL and PP where showing ((Refer Time: 33:08))

Come over here, turn around

Student: Sir

Turn around

Student: Turn around or this side

What you want to know

Student: Sir, like what is this HL, GL and PP, when I am looking at that hollow box

Stand here, turn around, turn around face class, I need a person taller than him

Student: ((Refer Time: 34:00))

Take your slippers off, you just face a class, so he is the station point Ayush Shekary of course, he has a top view and a front view, stay close to him ((Refer Time: 34:53)) tall enough, little forward, so let us say that he is looking at that light over there, so rather forget about the light, you looking at that pillar column over there. This guy is looking at the pillar from the top, so he has what is your name?

Student: Adithya

Adithya has a view of this guy's head and that pillar, and again that pillar is going to be top view for Adithya, so just imagine Adithya is in the sky flying he did not have wings, but still. So, he would have the top view of this guy's head Ayush's head and that column, which is what is this, so Adithya is going to be looking at Ayush standing here, and the column there. Now, you are looking at that, but you see one of those edges going into the wall, which is this edge for you.

Student: ((Refer Time: 36:27))

Why, you see the switch

Student: ((Refer Time: 36:32))

Fine forget about the wires, just the column focus, so look at the depth direction of the column which is this, now look at an object just imagine the wall is not there, look at an object which is far away along that direction. You will see a point where at what level will you see that point, at this level?

Student: No

So, Ayush is going to be seeing an object which is at infinity along that direction, along the line of his eye sight, Adithya ((Refer Time: 37:32)), Adithya is observing everything and he is nodding his head. So, before that the picture plane would be just kind of coinciding with the column, just going to be attached to the column the picture plane, the front face of the column is the picture plane.

So, this point which is what the image of the object which is far away along this direction, on the picture plane, Adithya will be able to see that, the top view guy he will be able to see that. And if I project this thing back on to your horizon line which is your

eye sight, this is where the vanishing points going to be, your ground line down below, down below ((Refer Time: 38:55)), so that is what is ground line is and what was he one know?

Student: I got it.

You got it, did you get it.

Student: ((Refer Time: 39:10)), I am at seeing at height is 0, when I looking at that object, because then only the...

In the top view, you have no height, so guys this entire thing is in the top view, this entire thing is in the top view, so it is pretty much like autographic projections happening, just that your recalling the image of this object on this picture plane and your projecting the image of your projecting this image over here, that would be your perspective.

Student: ((Refer Time: 39:47))

How is your...

Student: ((Refer Time: 39:53))

No, this is the storing the front view, ground line, horizon line.

Student: ((Refer Time: 39:59))

In top yes, but in the front you know, no no not in the front view, in the front view you are the boss, in the top view who is the boss. So, remember that this is the story of two views interacting with each other, station point upwards is top view, station point below, vanishing point, horizon line, ground line they all form a part of the front view, got it, two point perspective.

(Refer Slide Time 40:44)

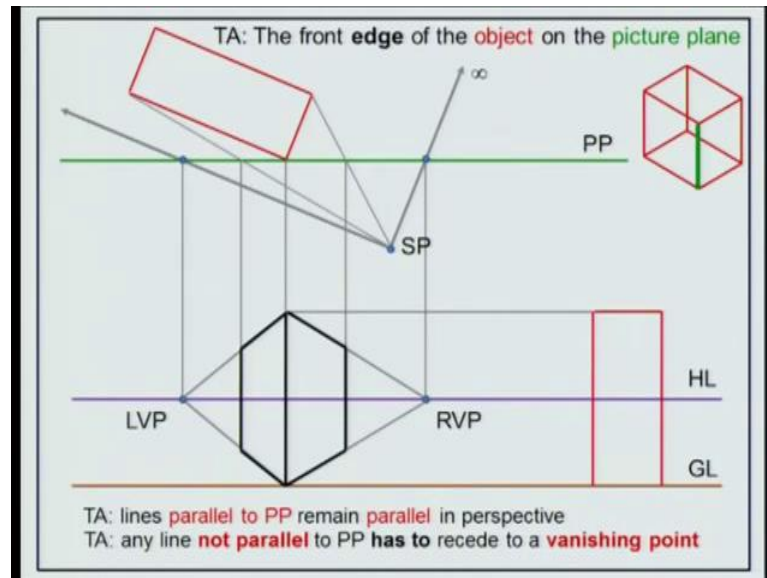

Same story, look at the same example, I am going to be making the slight change in that example, instead of having this face of the object on the picture plane I rotate the object in the top view, so that I have only a single edge on the picture plane. Now, stay with me here it is going to be important, stay with me is not the front face, but the front edge of the object that is on the picture plane. And remember this line below, any line which is not parallel to the picture plane has to recede to a vanishing point, how many lines you see are not parallel to the picture plane, careful.

Student: ((Refer Time: 41:51))

Careful

Student: ((Refer Time: 41:55))

How many lines are not parallel to the picture plane

Student: 8

8 are not parallel to the picture plane, 2, 4, 6, 8; all the edges which are going into the screen corresponding to these four vertices, they will remain or they will stay parallel to the picture plane, those which are parallel to the picture plane will remain parallel and perspective, those which are not parallel to the picture plane has to recede or they have to

recede to a vanishing point. Once again any line which is not parallel to the picture plane has to recede to a vanishing point stay with me here.

Now, look at the object look at the pair of lines, how many vanishing points you think you have, 2 if Ayush, Shekary is standing here and if Adithya is observing as a bird, then if Ayush is going to be looking at an object along this direction at infinity, well before that let us go over to the rules. Lines parallel to the picture plane will remain parallel in perspective, now back to that Ayush, Shekary standing at the station point and if he is looking at an object, which is at infinity along this direction, the image of that object will be found on the picture plane.

And the image is going to be what, the image is going to be a point, Ayush is about 1 inch or 2 inch taller than me, so his eye level is here, if he project that image from the top view onto this horizon line, he get the first vanishing point or the right vanishing point RVP. If he looks along the other direction and something which is at infinity, the image of that object will again be a point on the picture plane, project that thing down you will get the second vanishing point, which is the left vanishing point.

So, the two views are interacting with each other, the top view and front view, now focus on this vertex and focus on the corresponding edge, what you have to say about that?

Student: ((Refer Time: 45:01))

Is going to be true length, you will get the true length from the profile view, this is what the edge is going to look like, all the other 8 edges which are not on the picture plane, they will vanish towards the respective vanishing points. So, these edges whether they vanish, right or left, right, correct and these edges they are vanish...

Student: Left

To the left, so let us focus on this edges, which is this one and the edge below this, they both will vanish at RVP this thick edge and the other one will vanish are the left vanishing point. So, what you have, you have this edge in perspective, ((Refer Time: 46:19)) this edge in perspective, this edge in perspective here and this edge in perspective here.

What is left, this vertex is going to be where on this edge, and this vertex is going to be on this edge as well as on this edge two vertices, one below the other. Now, if Adithya observes Ayush in top view looking at that vertex, this would be the line of sight, the image of that vertex on the picture plane that corresponds to this point. So, this is how the image of that edge will be in picture plane, project this point down on both the edges, you will get the first edge, you will get the second edge.

And of course, you will have a vertical edge joining these two vertices, again if Ayush looks at this vertex from the station point in top view, this is how he would be seeing the image of that edge on the picture plane. If you project that image down you will have this edge and you will have this edge, how about this guy will it be visible or will it not be visible, will not be visible.

But, if you do the same exercise, if you do the same exercise ((Refer Time: 48:31)) this would be the corresponding image right there, right there, this would be the corresponding image project that thing down, if you do that exercise of course, these lines are going to be behind this. But, you would see that, the edge which is into the screen at that vertex will essentially be this vertical edge, although these lines are not very important for this perspective, so I will just let go of them. Now, the question is you see those 2 rules below satisfied, lines which are not parallel to the picture plane they have to vanish, lines which are parallel to the picture plane they remain parallel, is that true.

(Refer Slide Time 49:37)

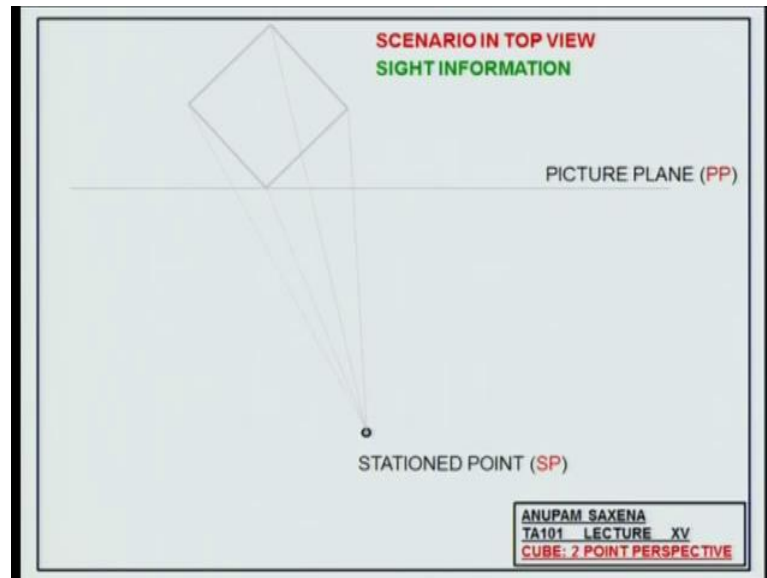

Again to emphasize we are combining two scenarios, one the top view, the other one in the front view, this is the slightly different example. The station point at different position you get the sight information, essentially these rays in setting with the picture plane, so these rays in setting with the picture plane in the top view. And then, you get the sight information from the profile view, you have the ground line, you have the horizon line, you have the station point, so you get the high information from here.

(Refer Slide Time 50:10)

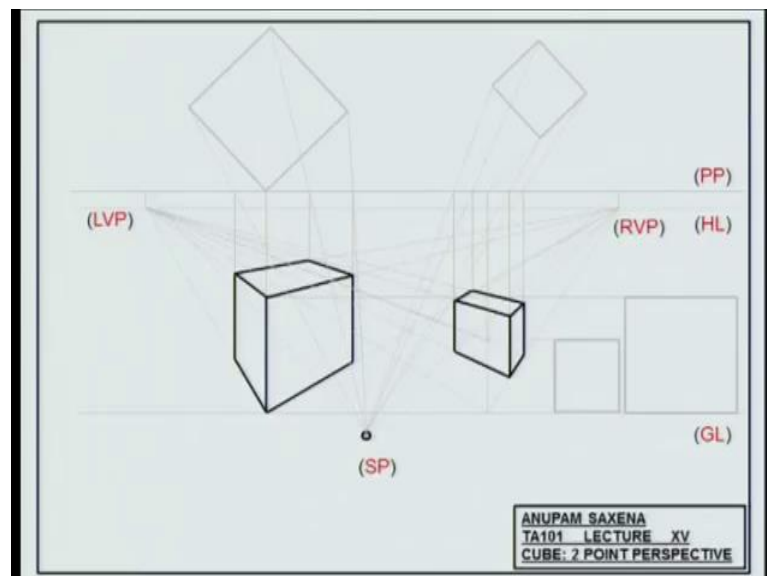

So, if the technique is clear to you, I will not say anything from now and just observe, this is what left vanishing point, right vanishing point, true height the edges, which are not parallel to the picture plane they vanish. You take the projections from different vertices at different point in the top view and get the perspective very nicely. So, remember it all depends on where your station, so for you the perspective is going to be different for you the perspective is going to be different.

So, it all depends on how your station with respect of the object as well as the picture plane, something important, if one of your edges or if the object is not on the picture plane then what, if the object is not on the picture plane or if any part of the object is not on the picture plane then what, what you do in this case? how do you get the true height? Let us say how do you get the true height of this edge, which is passing through this vertex and into the screen [FL] no idea.

One option of course, is to extend for the edges, extend this guy and imagine that this edge over here has moved to this edge, has moved to has moved along this edge. Now, if this edge has moved along this edge, which is now on the picture plane you can get the true length of that edge, so this would be in true length. Now, you would know that, this guy is going to be vanishing, now from where RVP you go to your station point of course, you have the station point, you look at this edge now here, look at this guy here, the image of this point on the picture plane is this, projected downwards.

So, this edge which is here will be in true length, but this edge here will show up like this, one more time stay with me, so any feature of the object is not on the picture plane gives extension, get a feature of the object on the picture plane. So, just imagine that this edge extends, this edge would vanish towards RVP the right vanishing point, this edge will vanish towards the left vanishing point.

And if you draw the line of sight from the station point and look at this vertex here, the image of this vertex on the picture plane will be this point, project that point in the front view. And this would be the perspective image of this edge; that is something that you need to keep in mind, rest should not be very difficult, should be straight forward. Just follow those 3 rules and you should be able to draw on a perspective, now just imagine the cube on the left of the station point, the cube on the right of the station point differentiate the perspective images of these two cubes, so there will be different.

(Refer Slide Time 56:19)

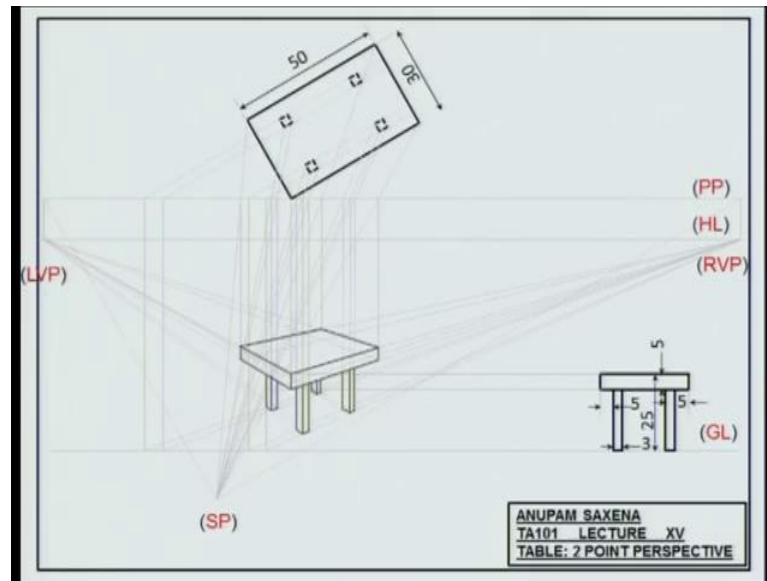

Just an example I think this going to be an animation, this going to be an animation those who wants to stay back, stay back those who want to ((Refer Time: 56:31)), just watch well you want to me to quiet, we have the slides also ((Refer Time: 57:31)) [FL]. So, just one point reminds me one nice story ((Refer Time: 58:07)), I was one last point, one last point I want to guys to appreciate difference between this figure and this figure.